



SEMI AUTO SHOTGUN INSTRUCTION MANUAL

READ THE INSTRUCTIONS AND
WARNINGS IN THIS MANUAL CAREFULLY
BEFORE USING THIS FIREARM

GUN SAFETY RULES

Observe these rules of safe gun handling.

1. Always keep the muzzle pointed in a safe direction. Watch the muzzle at all times: never point a gun, accidentally or intentionally, at any person or anything you do not intend to shoot. Identify the target before shooting; do not shoot at sounds.

2. Always treat any gun as if it is loaded - it may be!

3. Keep your finger off the trigger while operating the action and at all other times until you are ready to shoot.

4. Keep the safety "on" or in the "safe" position at all times until you are ready to fire the gun. Move to shoot. Up to the previous line after the word intend.

to shoot.

Do not rely on your gun's safety, the safety on any gun is a mechanical device and is not intended as a substitute for common sense or safe gun handling.

5. Learn how your gun functions and handles. If you do not thoroughly understand the proper use and care of your gun, seek the advice of someone who is knowledgeable.

6. Do not alter or modify any parts of a firearm.

7. Store guns unloaded, separate from any ammunition, and where children cannot get to them.

8. Be sure the barrel is clear of any obstructions before loading. Make it a habit to check the barrel every time before loading.

9. Be sure you have and use the proper ammunition. A 20 gauge shell will enter a 12 gauge chamber far enough so that a 12 gauge shell can be loaded behind it. Also, a 3 inch shell may fit into a 2 3/4 inch chamber, but the crimp at the mouth of the shell will unfold into the forcing cone. If either of these things occur and you fire the gun, the gun will explode, damaging the gun and possibly causing serious injury or death to you and those around you

10. Wear protective shooting glasses and adequate ear protection when shooting.

11. Never climb or jump over anything, such as a tree, fence, or ditch, with a loaded gun. Open the barrel, remove the shells, and hand the gun to a friend

or place it on the ground on the other side of the obstacle before crossing it yourself. Do not lean a gun against a tree or other object; it could fall and possibly discharge.

12. Do not shoot at a hard surface or at water. Bullet and shot can ricochet or bounce off and travel in unpredictable directions with great velocity.

13. Never transport a loaded gun. Do not place a loaded gun into a vehicle. The gun should be unloaded and placed into a case when not in use.

14. Never drink alcoholic beverages before or during shooting.

INTRODUCTION TO ADLER

For many of years, Adler has been associated with the gun industry. After the word with modern technology and you have a product of true value and affordable quality. You have Adler

We at Adler thank you for the privilege of delivering a product to you that will provide you with years of pleasurable use. Happy shotgunning.

ABOUT YOUR SEMI-AUTOMATIC SHOTGUN

Your Adler shotgun is gas operated. The gas created from firing a live shotshell operates the action. Once the first shell has been fired, the next shell in the magazine will automatically cycle into the chamber, and this cycle will continue (each time the trigger is pulled) until all shells loaded in the magazine have been fired. The bolt will remain locked in the open position after the last shell is fired.

The technologically advanced gas metering system allows you to shoot 2 3/4" and 3" shells interchangeably with any ammunition of the proper gauge for your shotgun with flawless performance. This and other fine features ensure that your shotgun will be a source of pride and pleasure for years to come. For 3 1/2" models the metering system allows you to shoot heavy 2 3/4", 3" and 3 1/2" shells interchangeably.

SAFETY SWITCH OR BUTTON

The safety is designed to stop the trigger mechanism.

DON'T RELY ON YOUR GUN'S SAFETY. TREAT EVERY GUN AS IF IT WERE LOADED AND READY TO FIRE. The safety on any gun is a mechanical device, and it is not intended as a substitute for common sense or safe gun handling. Always keep the muzzle pointed in a safe direction.

A. The safety is located behind the trigger, and provides protection against accidental or unintentional discharge under normal usage when properly engaged.

B. To engage the safety, push the button so that it protrudes from the right side of the gun and the **RED BAND MARKING CAN NOT BE SEEN**. The safety should always be in the "on" or "safe" position until you intend to fire the gun (photo 1).

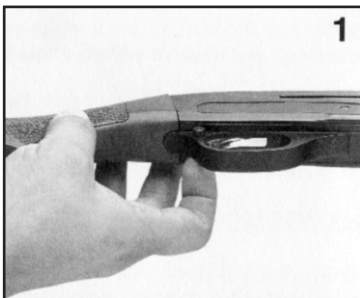

C. When you are ready to fire the gun, press the safety button to the "off" or "fire" position, so that the safety protrudes from the left side of the gun and the **RED BAND MARKING IS SHOWING**.

DANGER: The gun will fire when the trigger is pulled intentionally or accidentally when the **RED BAND MARKING IS SHOWING**.

ASSEMBLY

In the packing, the shotgun is divided into two parts: receiver and barrel group (photo 2).



To assemble the gun, follow the steps below:

Unscrew the cap (photo 3) and remove the forend (photo 4).

Pull the bolt hanging latch placed on the rear side of the carrier (photo 5).

Assemble the barrel while centering the magazine and the receiver (photo 6).

Reassemble the forend (photo 7) and screw the cap onto the threaded magazine tube (photo 8).

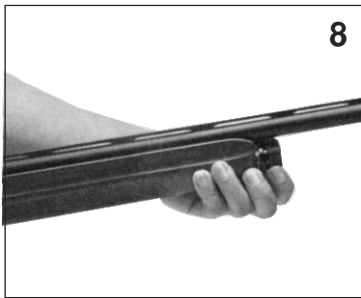
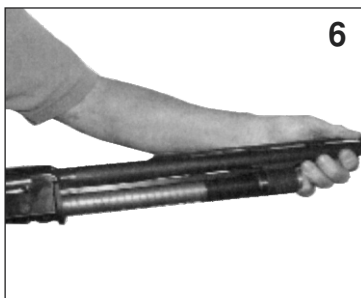
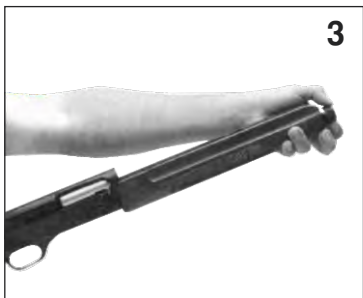

LOADING YOUR SHOTGUN

You can load your shotgun in the following ways:

1. Be certain the safety is in the "on" or "safe" position (see section regarding operation of the safety on pages 3 and 4).

Draw or pull the bolt rearward until it locks in the open position (photo 12). Place a shell into the breach (photo 9). Release the bolt by pressing the button located toward the front of the receiver (photo 10). **This chambers a round, and the gun will fire if the trigger is pulled with the safety in the "off" or "fire" position.** You can then load additional shells into the magazine by inserting them through the loading port on the bottom of the receiver and pushing them into the magazine (photo11).

2. Be certain the safety is in the "on" or "safe" position (see section regarding operation of the safety on pages 3 and 4).

Draw or pull the bolt rearward until it locks in the open position (photo 12). Load shells into the magazine by inserting them through the loading port on the bottom of the receiver and pushing them into the magazine (photo 11). Push back the magazine shell latch on the rear side of the carrier (photo 13). This allows the shell to exit the magazine and move onto the carrier. Release the bolt by pressing the button located toward the front of the receiver (photo 10). **This chambers a round, and the gun will fire if the trigger is pulled with the safety in the "off" or "fire" position.**



UNLOADING YOUR SHOTGUN

Be certain the safety is in the "on" or "safe" position (see the section regarding operation of the safety on pages 3 and 4). Rapidly draw or pull the bolt reaward to eject any shell in the chamber (photo 12). Lock the bolt open by pressing the button located toward the front of the receiver (photo 13). Lift the carrier and push on the magazine shell latch (photo 14). The shells in the magazine will be ejected.

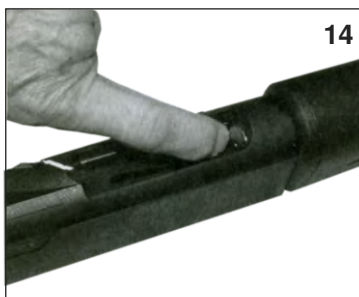

DISASSEMBLY

Unscrew the forend cap.

Take the forend and the barrel off (photo 15).

Take the handle off from the bolt and then all the bolt assembly (photo 16).

With a tool, push the pin(s) of the trigger group out (photo 17) and take the trigger group off (photo 18).

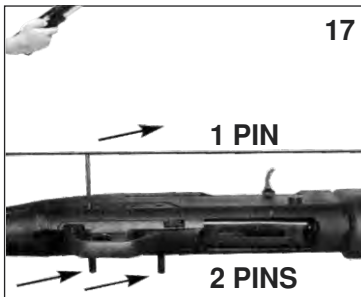
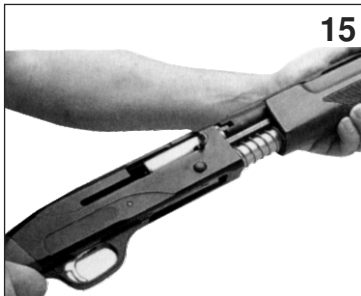

REASSEMBLY

Assemble on the magazine tube, the action spring and insert the bolt group into the receiver.

Insert the handle into its hole.

Reassemble the trigger group fixing it with the pin(s).

SPARE PARTS

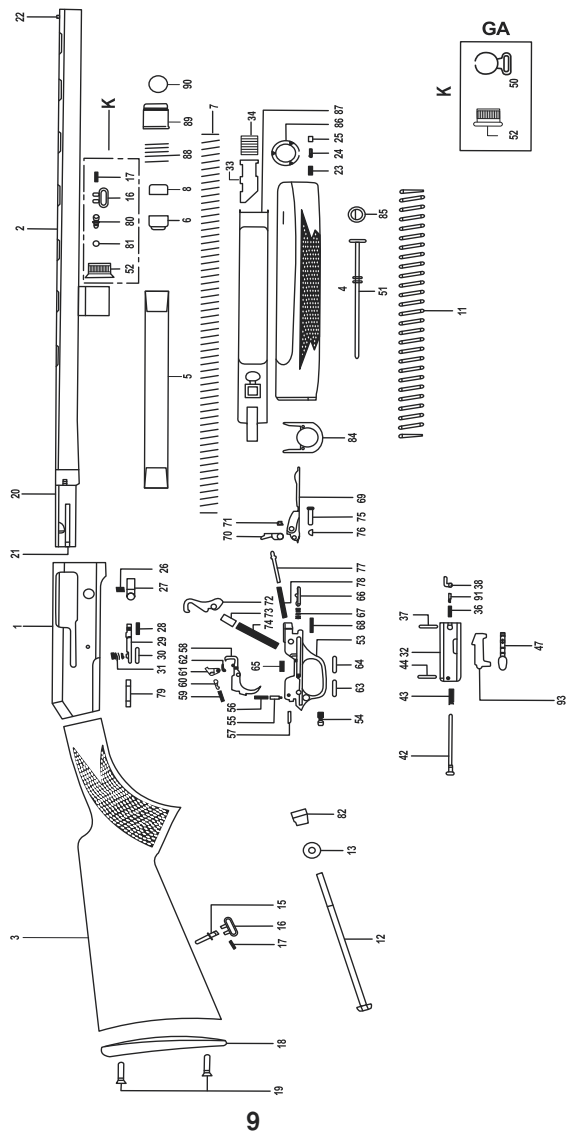





PART NO	DESCRIPTION
1	RECEIVER
2	BARREL
3	STOCK
4	FOREARM
5	MAGAZINE TUBE
6	MAGAZINE FOLLOWER
7	MAGAZINE SPRING
8	MAGAZINE SPRING RETAINER
11	ACTION SPRING
12	STOCK BOLT
13	STOCK BOLT WASHER
15	STOCK SWIVER STUD
16	STOCK SWIVEL
17	STOCK SWIVEL PIN
18	BUTT PLATE
19	BUTT PLATE SCREW
20	BEARING BOLT
21	EJECTOR
22	FRONT BEAD
23	MAGAZINE CAP SPRING
24	MAGAZINE CAP PIN
25	MAGAZINE CAP SCREW
26	BOLT RELEASE SPRING
27	BOLT RELEASE
28	BOLT RELEASE PIN
29	BOLT RELEASE LATCH
30	BOLT RELEASE LATCH PIN
31	BOLT RELEASE LATCH SPRING
32	BREECH BOLT
33	ARM PIPE
34	CONNECTION RUBBER
36	EXTRACTOR SPRING BOLT
37	EXTRACTOR RETAINIG PIN
38	EXTRACTOR
42	FIRING PIN
43	FIRING PIN SPRING
44	FIRING PIN RETAINER
47	OPERATING HANDLE
50	FRONT SWIVEL
51	MAGAZINE PLUG

PART NO	DESCRIPTION
52	MAGAZINE CAP
53	GUARD
54	SAFETY
55	SAFETY PLUNGER
56	SAFETY SPRING
57	SAFETY PLUNGER
58	TRIGGER
59	SEAR SPRING
60	SEAR PLUNGER
61	SEAR
62	SEAR PIN
63	TRIGGER PIN
64	TRIGGER PIN
65	TRIGGER SPRING
66	CARRIER PLUNGER
67	CARRIER SPRING
68	CARRIER RETAINING PIN
69	CARRIER
70	CARRIER LATCH
71	CARRIER LATCH PIN
72	HAMMER
73	HAMMER PLUNGER
74	HAMMER SPRING
75	TRIGGER ASSEMBLY PIN SLEEVE
76	TRIGGER ASSEMBLY PIN RETAINER
77	CARRIER LATCH PLUNGER
78	CARRIER LATCH SPRING
79	TRIGGER GUARD
80	SWIVEL STUD
81	SWIVEL STUD RETAINER
82	STOCK BOLT RECEIVER
84	PLATE
85	MAGAZINE PLUG RETAINER
86	MAGAZINE CAP SUPPORT
87	ACTION BAR
88	GAS PISTON SPRING
89	GAS PISTON
90	RUBBER GAS RING
91	EXTRACTOR SPRING
93	LOCKING BLOCK

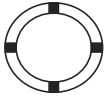
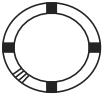
USAGE OF CHOKE TUBES

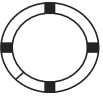
The choke is what controls the openness or tightness of the pattern of your shotgun. The chart below lists the choke available (from open to tight), and the corresponding marks that indicate the choke of your specific shotgun.

	SKEET	IC	M	IM	F	XF
CHOKE TUBE						
BBLs	CL	****	***	**	*	XF

Never fire or run gun cleaning tools through a barrel that uses choke tubes without having a choke tube installed. The threads of the choke tube and the internal threads of the barrel should be cleaned after each use and before installation of the tube.

To install a tube, insert the tube into the barrel and tighten with your fingers. Once the tube is finger tightened, tighten with the appropriate choke-tube wrench until the tube is snug. **DO NOT over tighten or forcefully tighten with wrench.**

MAINTENANCE AND CLEANING

Caution: Make sure the gun is unloaded.

1. Make sure that the broad, polished, finely fitted mating surfaces of the breech block and receiver are especially clean and lightly oiled with a high quality gun oil. Do not use pure silicone or lanolin.

2. Run an oil patch through the bore with a cleaning rod starting from the breech end. To prevent leading, use a cleaning solvent and brass brush to clean the bore periodically. Follow this cleaning with one or two clean oilpatches. **Important:** If your gun is equipped with choke tubes, do not use a brass brush to clean the barrels unless a choke tube is installed in each barrel. Barrels that utilize choke tubes must also have the choke tubes removed to clean and oil the threads inside the barrel and the choke tubes themselves. This will protect the threads from being damaged by cleaning tools and also prevent a dirt build up that would cause the choke tube to become difficult to remove from the barrel. Damage can result to choke tubes and barrel when attempting to remove sticky choke tubes.

Never fire your gun without choke tubes snugly tightened in barrels. Do not over tighten choke tubes. Wipe all exposed metal surfaces with an oiled cloth before storing. Do not squirt or pour oil into the inside mechanism because it may

hamper proper functioning and will soak the wood. After extended periods of heavy use, your gun should be taken to a qualified gunsmith to have the action disassembled for professional cleaning and lubrication.

3. Care for your wood stock and forearm the same way you would a piece of furniture with the same finish.

STORAGE

Clean thoroughly and oil your gun before storage. Store the gun in a case to prevent scratches and dents. Store in a dry place to prevent corrosion. **Store the gun away from children and in place where it cannot be obtained by those unauthorized to use it. Always store gun unloaded and separately from any ammunition.**

IMPORTANT

USAGE OF STEEL SHOT

The choke (bore constriction) in all modern shotguns has been established based on the pattern performance of shot shells loaded with lead shot. When using the steel shot shells, you will notice a different performance in pattern density versus the established lead shot pattern, because the steel shot is harder and lighter than lead shot.

You should be aware of the following differences and cautions:

Never shoot steel shot loads in a full choked barrel or full choke tubed barrel. To do so may cause the barrel to swell or rupture. In general, steel shot fired with a modified choke will produce the equivalent of a lead full choke pattern. This will be true of all steel shot sizes up to and including no. 2. The established improved cylinder chokes will produce the equivalent of a (lead) modified choke pattern.

All steel shot sized larger than no. 2, and including special sized such as -F-, "T", etc., should be used only with improved cylinder chokes. These steel shot sized, when used in improved cylinder chokes, will produce patterns equivalent to (lead) full choke patterns. The established cylinder choke or bore will produce the equivalent of a modified (lead) pattern.

Additional information concerning the use of steel shot is available from Remington, Winchester, Federal and other ammunition companies.

PARTS

To order parts, please furnish the following information: Your name, address, telephone number, firearm serial number, maker and model. When we receive your request we will send you an order form and a parts breakdown with prices.

SERVICE AGREEMENT AND LIMITED WARRANTY

Adler agrees to service its products free of charge for defects in materials and workmanship in accordance with the service agreement listed below. The obligation of Adler under this agreement is limited to the repair or replacement of unserviceable parts and does not cover any incidental or consequential damages. Other than the express warranty contained herein Adler makes no warranties, express or implied.

Adler will repair or replace any unserviceable part(s) for one (1) year from date of purchase and further will supply free parts (Wood not included) for an additional four (4) years in accordance with the above warranty statement provided your firearm had not been altered, abused, willfully damaged, or damaged by overpressure ammunition. This agreement is not transferable; its benefits apply only to the original purchaser.

To obtain free service during the time this agreement is in effect, make sure your firearm is unloaded, and send it to Adler

This agreement and the warranties contained herein are void if your registration card is not received with a copy of your sales slip within 30 days from date of purchase

SHIPPING

When returning your gun for service, please take care in packing. Disassemble your gun, wrap in paper or other protective media and place gun in the original box. (THIS BOX WILL PROTECT THE GUN BUT IS NOT DESIGNED FOR SHIPPING). Wrap box in a cardboard box approved for interstate shipping. Adler is not responsible for damage incurred during shipping.

INSTALLATION OF MAGAZINE PLUG

Some Federal, State and local hunting regulation may require that a shotgun be limited to a maximum shell capacity of three (3) rounds.

Your shotgun has been packed with a magazine plug for this purpose.

Installation:

1. Remove the forend screw cap, the forend and the barrel.
2. At the threaded end of the magazine tube (where the forend screw cap fits) you will locate a black snap ring.
3. A large blade screw driver should be used to remove the snap ring.
CAUTION: The snap ring will be under pressure from the magazine spring. Do not remove the snap ring in a manner where the ring could fly out and strike you or anyone else causing injury, particularly to the eye.
4. Compress the magazine spring into the magazine tube, and insert the magazine plug (small end first). Push the magazine plug and insert the snap ring so the snap ring end is flush with the end of the tube.

THANK YOU

Thank you for purchasing a Adler shotgun We are sure this gun will bring you years of hunting and/or shootin pleasure. Your satisfaction is the key to our success. Please let us know if we can be of service and please relay any observations about your guns performance or appearance.

PURCHASER'S RECORD

Model Number _____

Purchase Date _____

Gauge or Caliber _____

Serial Number _____

Purchase Price _____

Store Name _____



www.adlerarms.com

Tel.Fax : +90 332 524 66 61
ÜZÜMLÜ - BEYŞEHİR / KONYA / TURKEY